

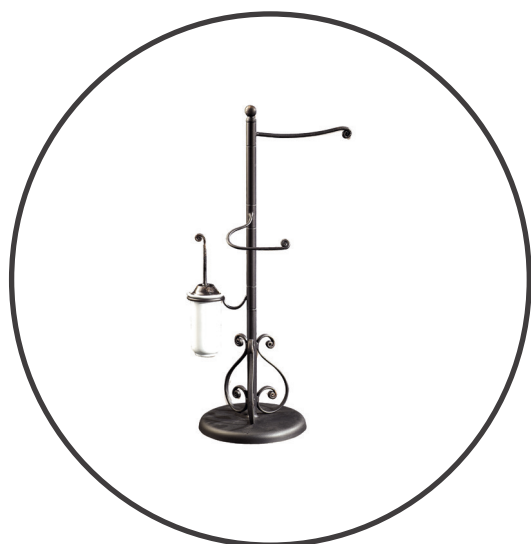

” ACCESSORI - ACCESS.



ANAC15

” SCHEDA TECNICA/TECHNICAL SCHEME/ТЕХНИЧЕСКИЕ СХЕМЕ:

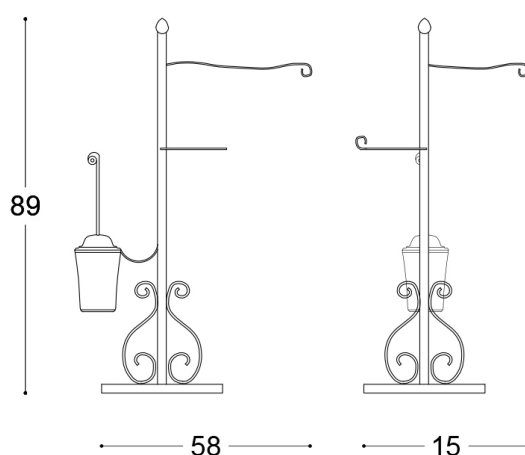

GAIA Srl

Via Statale 467 n°153 - 42013 S. Antonino di Casalgrande (RE) - ITALIA - P. Iva 02827180361

Tel. (0039) 0536 894850 - Fax 0536 894851 - gaia@gaiamobili.it - www.gaiamobili.it

