

GAIA

ITALIAN BATHROOM DESIGN



Sanitari e Consolle - Capri - PHCA21

Scheda Tecnica-Technical Scheme

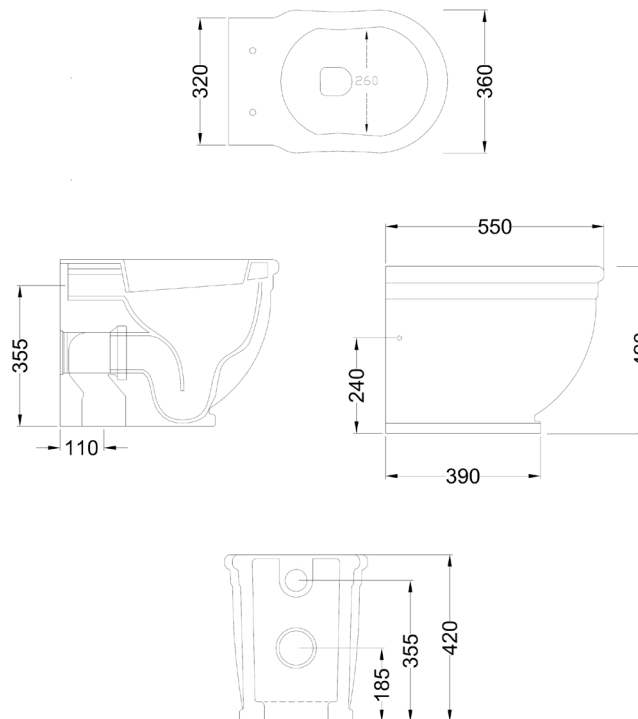

Senza brida - Rimless

GAIA Srl

Via Statale 467, 153 - 42013 - S. Antonino di Casalgrande (RE) - Italia - P.Iva 02827180361
Tel. (0039) 0536 894850 - Fax 0536 894851 - gaia@gaiamobili.it - www.gaiamobili.com



#GaiaMobili